

diatostyle

Bioclimatic pergola



**Expanding your
outdoor living space
and views without
limits**



Bioclimatic pergola

The **Bioclimatic pergola** allows you to increase your useable living area without the need for any additional building works, and is a perfect solution for terraces, gardens, hotels and restaurants. All year round use is genuinely viable with it's motorized rotating roof slats which can be opened when the weather permits from between 45° and 135°

The **Bioclimatic pergola** offers various options for extra comfort such as LED lights, heaters, rain sensors for self closing, sliding glass doors, zipped blinds and more. All functions can be operated by a wireless remote control hand set, Smartphone or Tablet.

diato Bio

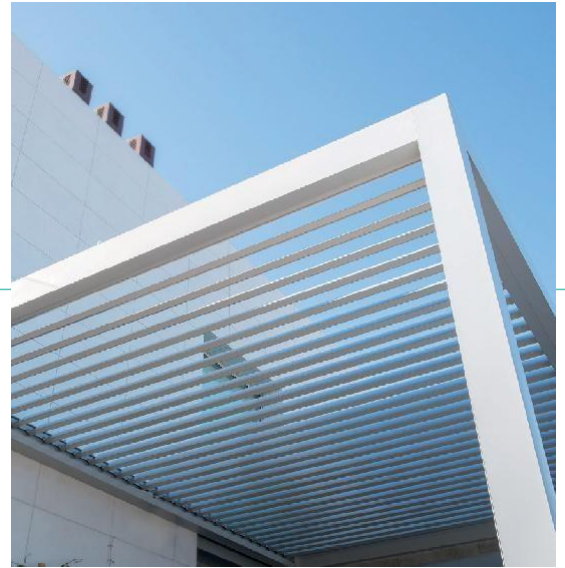

Ventilation



Rain Protection



Sun Protection



Automation

FUNCTIONALITY



VENTILATION

Temperature can be controlled in a natural way thanks to motorized roof slats (45°, 90° and 135°) that allow the air to circulate during summertime when opened, and retain heat during the winter months when closed.

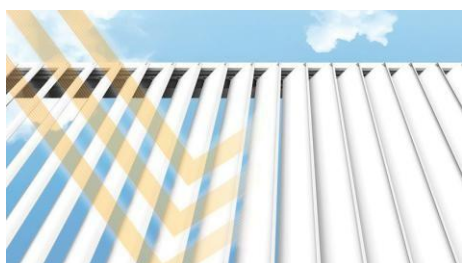

SUN PROTECTION

You can adjust the aluminum roof slats orientation either by wireless remote control or by using an App with your Smartphone or Tablet.

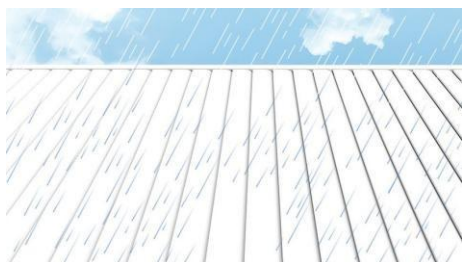

RAIN PROTECTION

Specially designed aluminum roof slats collect water and using a pipeline system take collected water through lateral columns to the outside.

ROTATING ALUMINUM SLATS

Rotating aluminum roof slats controlled either by wireless remote, Smartphone or Tablet.

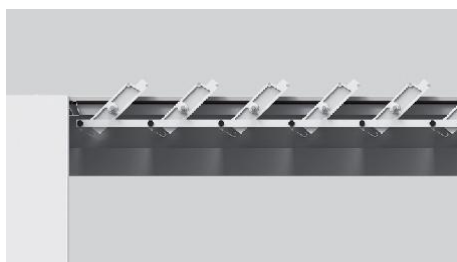
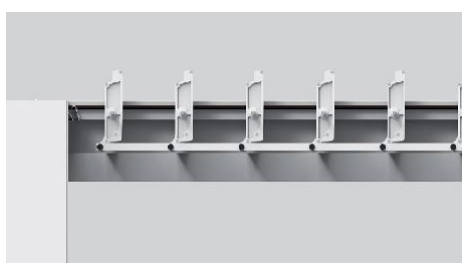
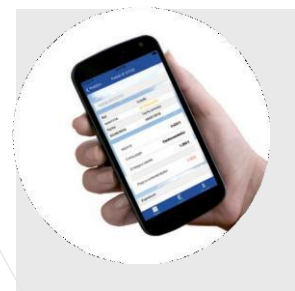
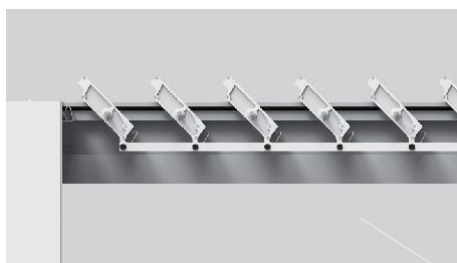
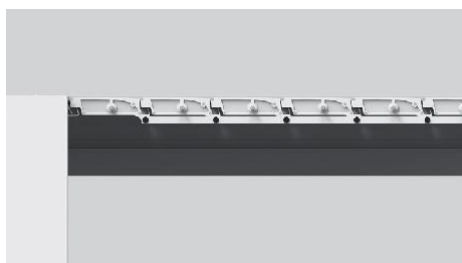

Technical Details



50MM PIPELINE DRAINAGE *OPTIONAL*
System for water drainage through columns.

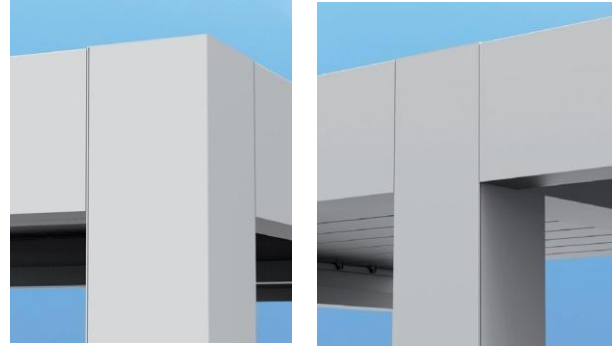

BEAMS AND PERGOLA CONNECTION
The union of beams with the pergola's structure does not disrupt the aesthetics as the connection of these elements has a clean and elegant finish. One column joins additional modules allowing for extra useable space as well as reducing the visual impact.



PATENTED ANTI SPLASH SYSTEM
Features a modern anti splash system in the beams.

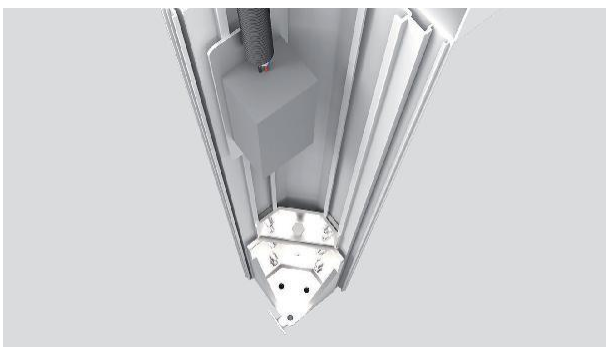

REMOVABLE COLUMN FACE PLATE
Thanks to this system, installation and maintenance of the pergola is easily accessible.



ROOF SLATS WITH POLYSTYRENE *OPTIONAL*
Adding polystyrene into the slats allows us to create a sound isolation when it rains.

VARIETY OF CONFIGURATIONS

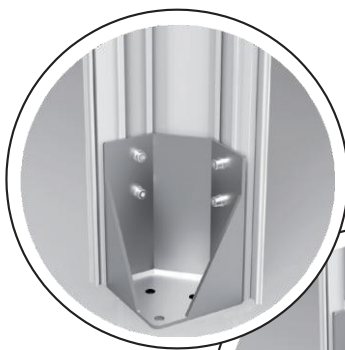
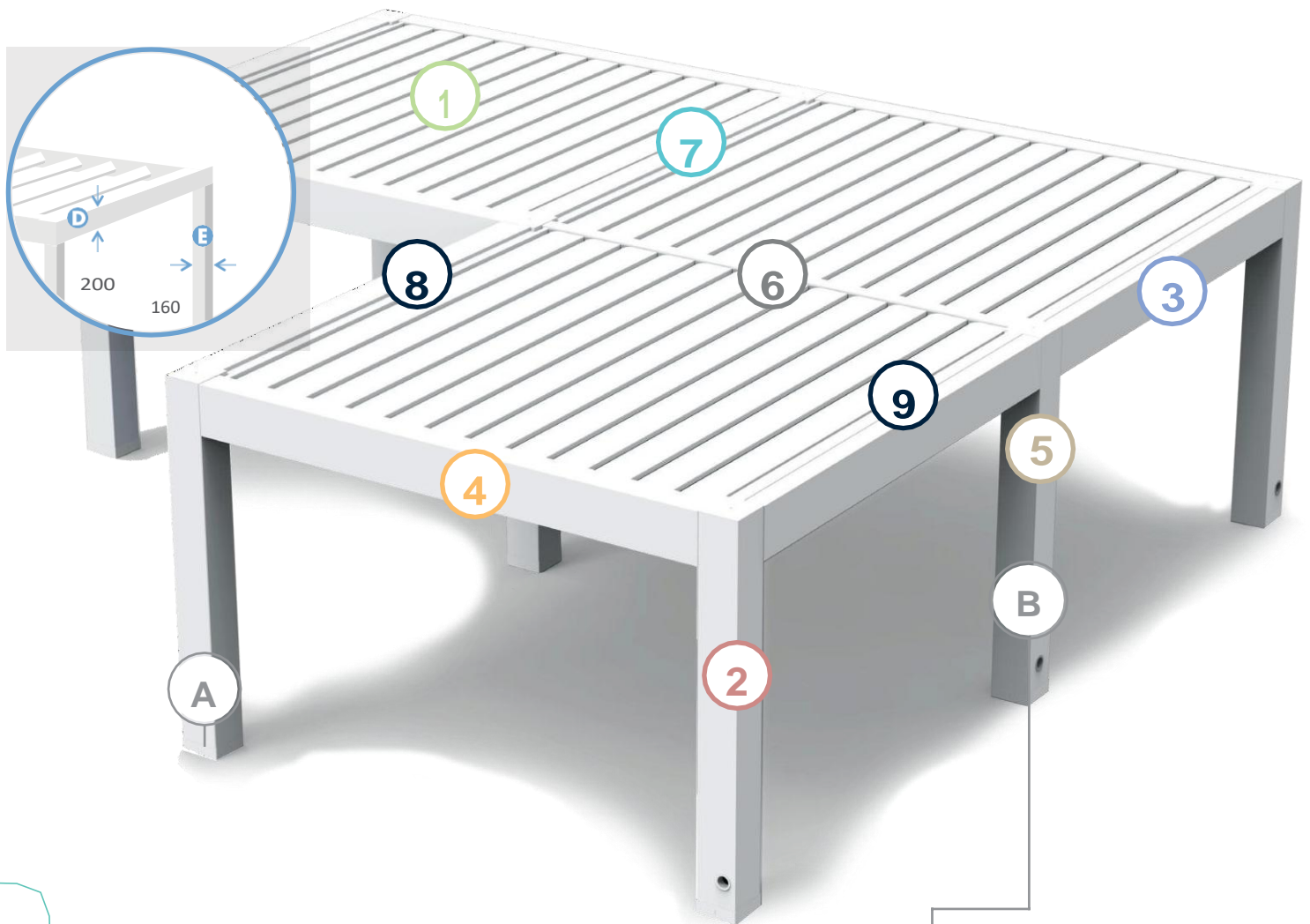

A-SUPPORT TYPES

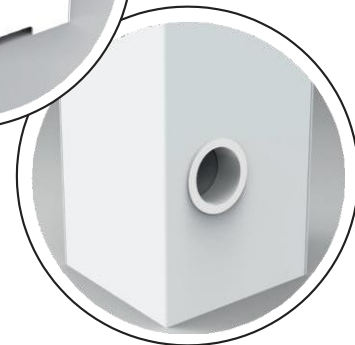
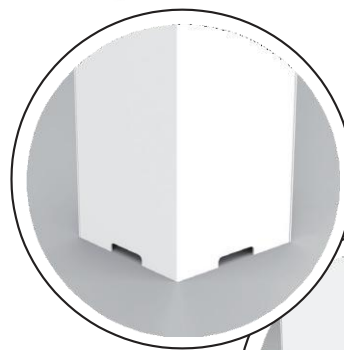

B-DRAINAGE TYPES

MAXIMUM DIMENSIONS

diato-bio can be custom made using different variations, depending on where the installation will take place so it can be adapted to customer's needs.

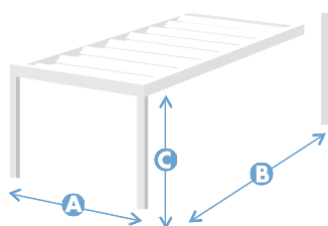
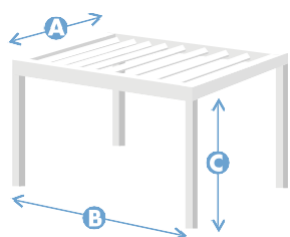

4 OR 2 COLUMNS

A	Maximum width	4.000 mm
B	Maximum length	6.450 mm
C	Maximum width	3.000 mm

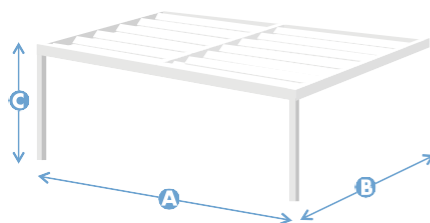
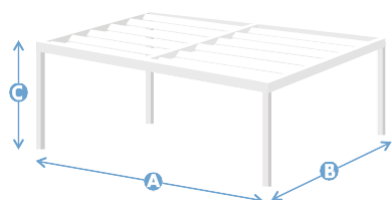

DUPLEX
4 OR 2 COLUMNS

A	Maximum width	6.500 mm
B	Maximum length	6.450 mm
C	Maximum width	3.000 mm

VARIETY OF CONFIGURATIONS

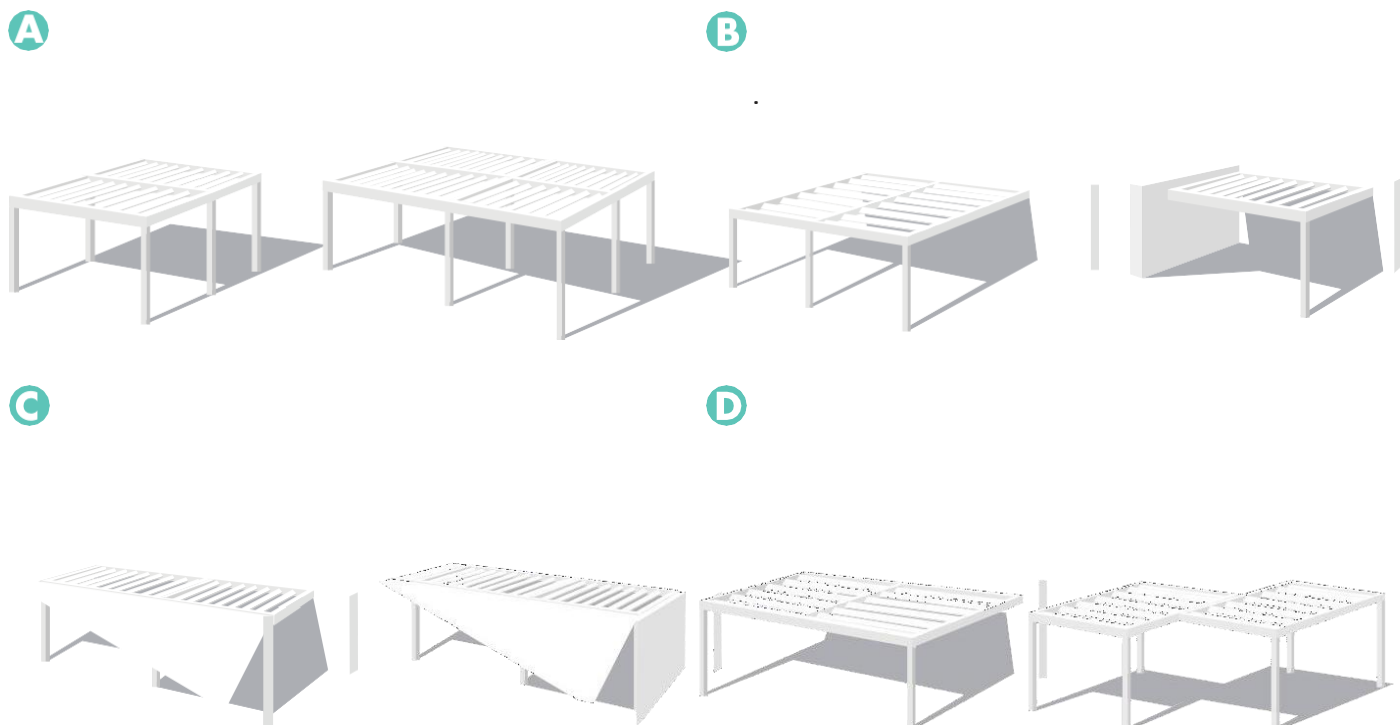



AUTOMATION

All of your pergola functions can be configured so that they are controlled by wireless remote control or with the 'T-Mate' app, your Smartphone or Tablet.



OPTIONAL LIGHTING

There are 4 different lighting options:

- Spot lights
- LED strips
- Perimeter LED
- Beam spot lights

Thanks to 'T-MATE', illumination pack can be programmed for switching on and off at any time, and for controlling light intensity.





SOUND PACK

Integrated sound system allows you to listen to your favorite music with a direct radio access, USB adaptor and Bluetooth. Speakers are available in either black or white.

Sound system can be controlled with wireless remote control (not the same one that controls roof slats opening), Smartphone or Tablet.

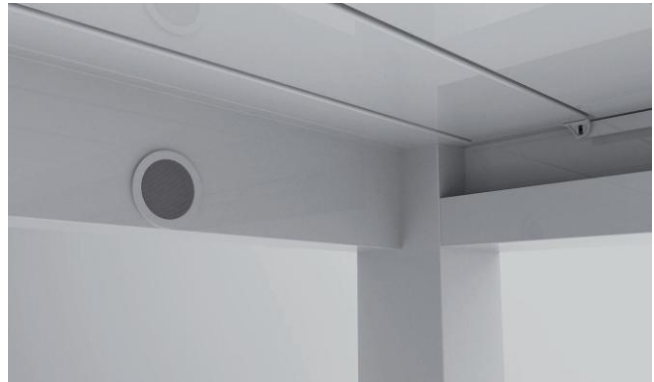

INFRARED HEATERS

The addition of an infrared heater allows you to enjoy a pleasant temperature even on very cold winter days. Heater can be controlled using the same wireless remote control as you use for slat opening.



AUTOMATIC SENSORS

Thanksto rain and wind sensors the inside of the pergola [seesky-bio](#) is automatically protected against harsh weather conditions.



Rain Sensor



Wind Sensor

SKY-LIGHT OPTION

Lets natural light in even when roof slats are closed.

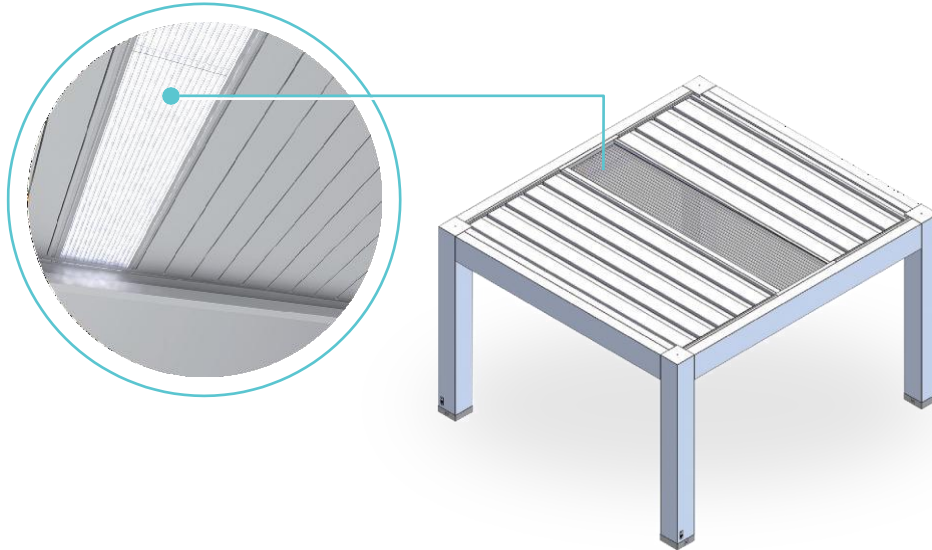

OPTION SHIFTEN COLUMN

Pergola can be adapted to existing structures by inseting columns (maximum 1000 mm).



OPTION CABLE ATTACHMENT

There is a possibility of fastening pergola to the wall and allowing an installation without columns.

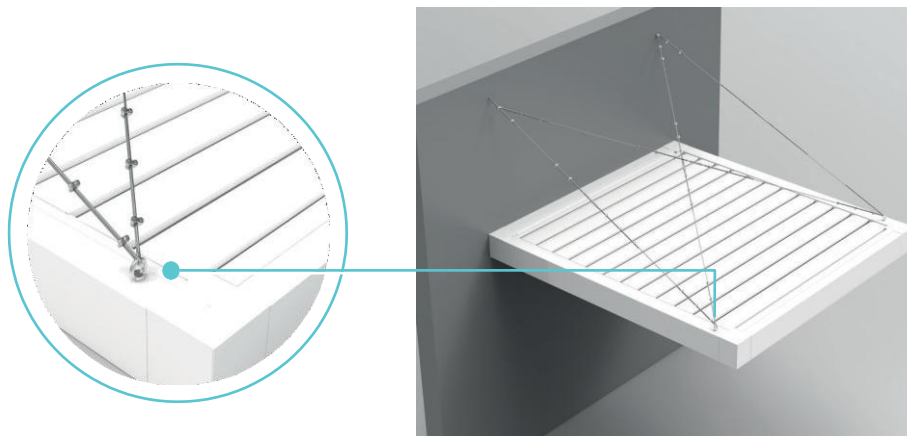

GLASS ROOM

Creating a fully enclosed Glass Room means you will be able to enjoy natural light and that outdoors feel for the majority of the year in a comfortable and inviting environment.

SLIDE & STACK GLASS DOOR SYSTEM

The sliding and stacking system gives you the maximum walkthrough area possible when open. Can be configured with a 'traffic' door and is lockable.

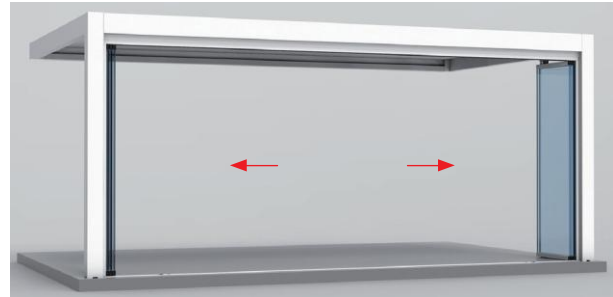

SLIDING GLASS DOORS

Lockable sliding glass doors allow you to have fewer glass panels across a span.

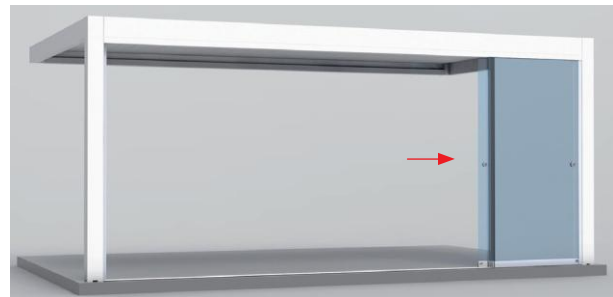

SUN PROTECTING ZIP SCREEN

Wireless remote controlled Zipped Screens to protect against excessive sun, heat and wind.

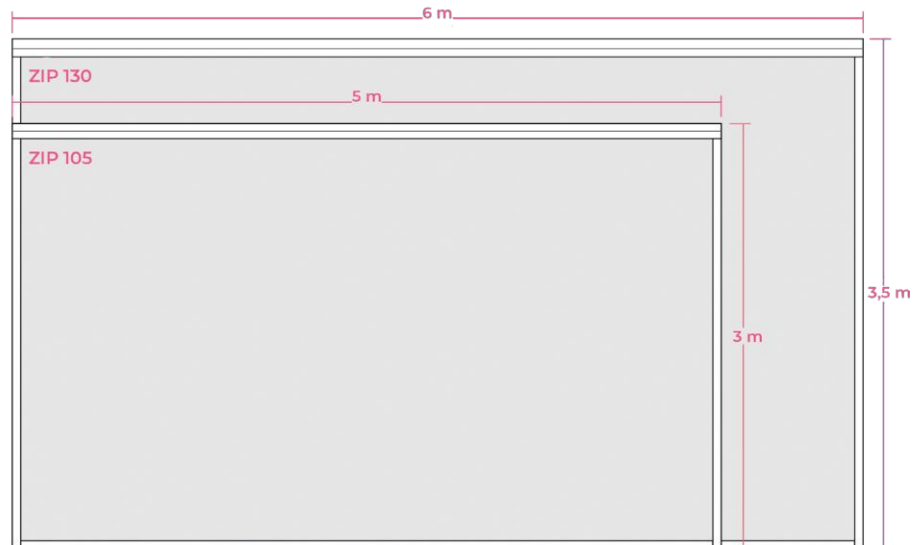
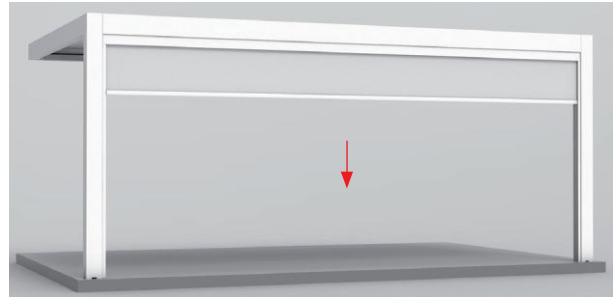

⁽¹⁾ Mechanical motor
⁽²⁾ Radio motor



PYME INNOVADORA

Válida hasta el 06 de agosto de 2023



Diatostyle Ltd, 27 Old Gloucester Street, London WC1N 3AX · Tel: 0800 975 0064
 sales@diato.co.uk · www.diato.co.uk

diatostyle

The purpose of this document is for general information only. Specifications and options are constantly updated and may vary from those shown. You should not rely on this document's contents on making a decision to buy, a written quotation, which is personal to you, will be provided for that purpose.